

SIZE	-0091
PCLC	1002 mm
PIN / GAP	34.93 mm
BORE DIA	105 mm
ROD DIA	35 mm
STROKE	425 mm
WEIGHT	62.60 Kg
FULL BORE AREA (PUSHING/EXTENDING)	8659 mm ²
ANNULUS AREA (PULLING/RETRACTING)	7697 mm ²
GAS DISPLACEMENT (FULL BORE SIDE)	3.68 ltrs
OIL DISPLACEMENT (ANNULUS SIDE)	3.27 ltrs
MAXIMUM PUSH FORCE @ 5 BAR	441 Kg (4330 N)
PULL FORCE @ 150 BAR	11769 Kg (115454 N)
PULL FORCE @ 250 BAR	19615 Kg (192423 N)
MAX PULL FORCE @ 350 BAR (RELIEF)	27461 Kg (269392 N)

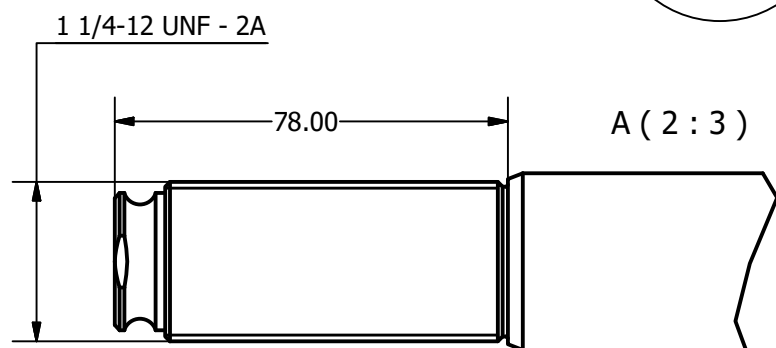
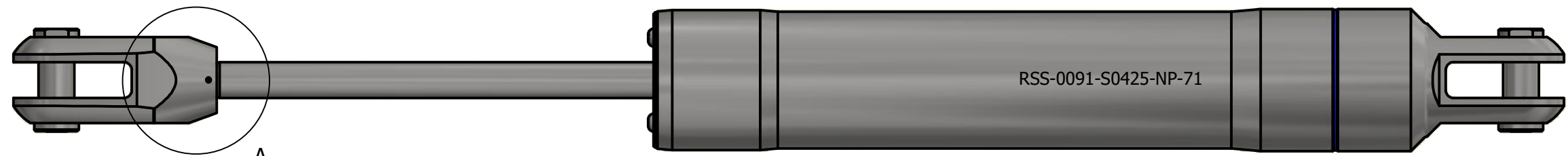
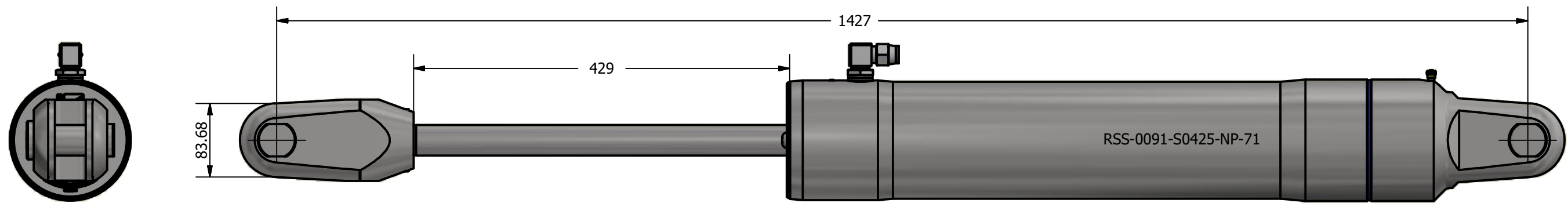
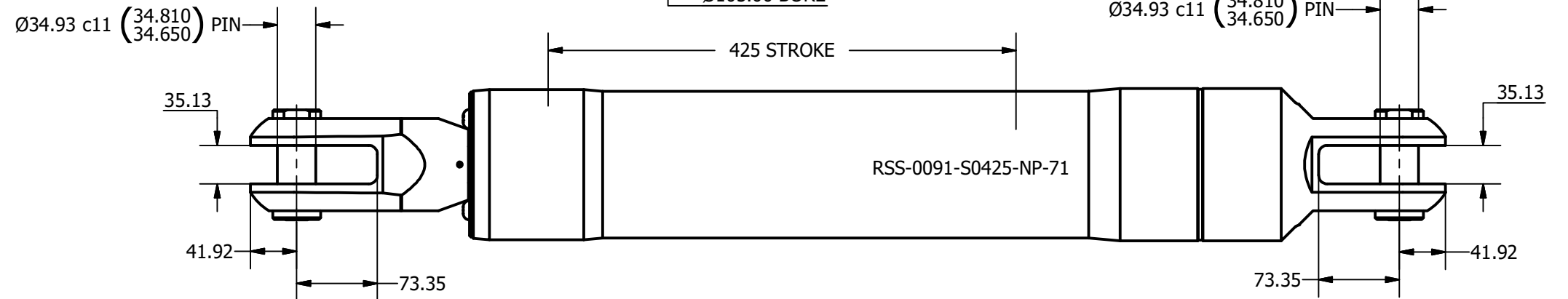
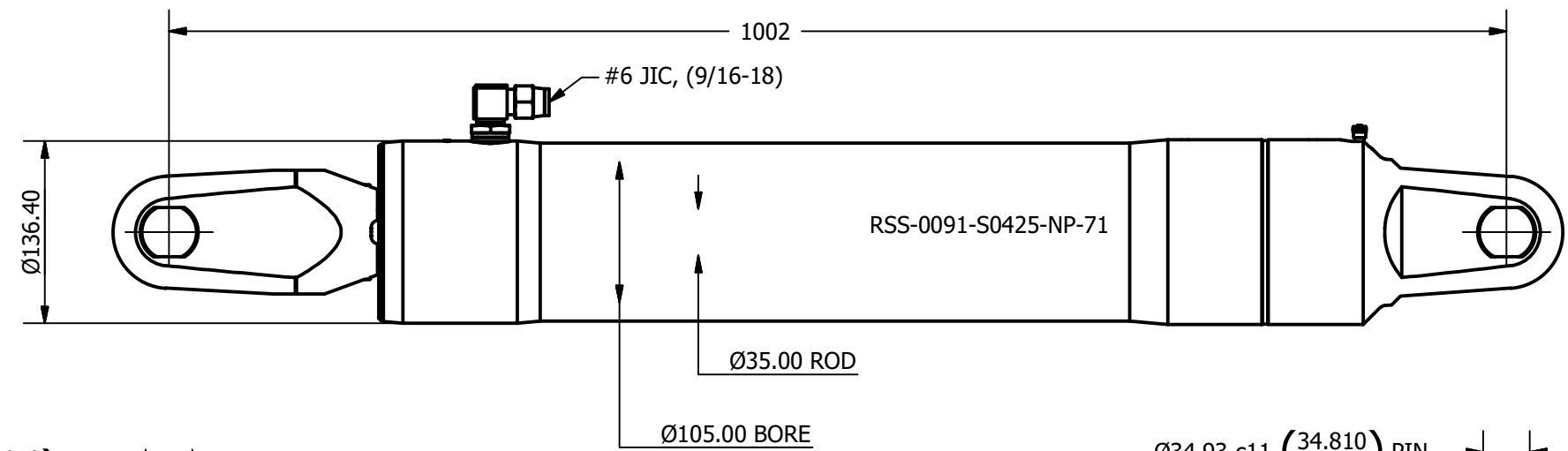

NOTE: CUSTOM STROKES, LENGTHS AND CLEVIS DIMENSIONS AVAILABLE UPON REQUEST

	Title STAINLESS SINGLE ACTING GAS RETURN CYLINDER		Revision 2
	Drawing No. RSS-0091-S0425-NP-71		Date Drawn By 10/11/2021 AL
	Tel: +44 (0)1202 596630 www.oms.ltd		© Copyright. All rights to this drawing and design are the sole property of OMS Ltd. This drawing must not be copied, communicated or loaned to any third party without the written consent of OMS Ltd.