

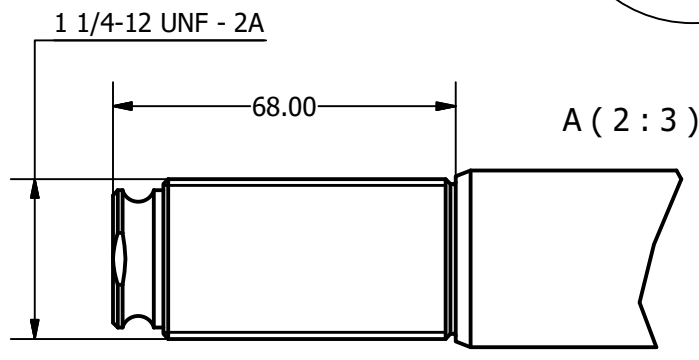

SIZE	-0060
PCLC	877 mm
PIN / GAP	31.75 mm
BORE DIA	92 mm
ROD DIA	35 mm
STROKE	375 mm
WEIGHT	40.24 Kg
FULL BORE AREA (PUSHING/EXTENDING)	6648 mm ²
ANNULUS AREA (PULLING/RETRACTING)	5685 mm ²
GAS DISPLACEMENT (FULL BORE SIDE)	2.49 ltrs
OIL DISPLACEMENT (ANNULUS SIDE)	2.13 ltrs
MAXIMUM PUSH FORCE @ 5 BAR	339 Kg (3324 N)
PULL FORCE @ 150 BAR	8693 Kg (85282 N)
PULL FORCE @ 250 BAR	14489 Kg (14217 N)
MAX PULL FORCE @ 350 BAR (RELIEF)	20285 Kg (198992 N)

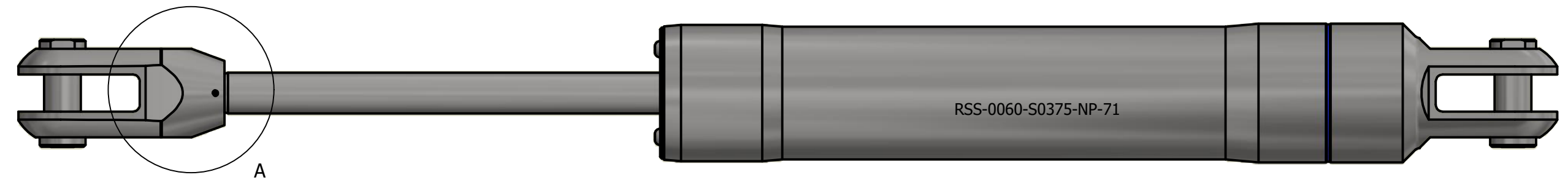
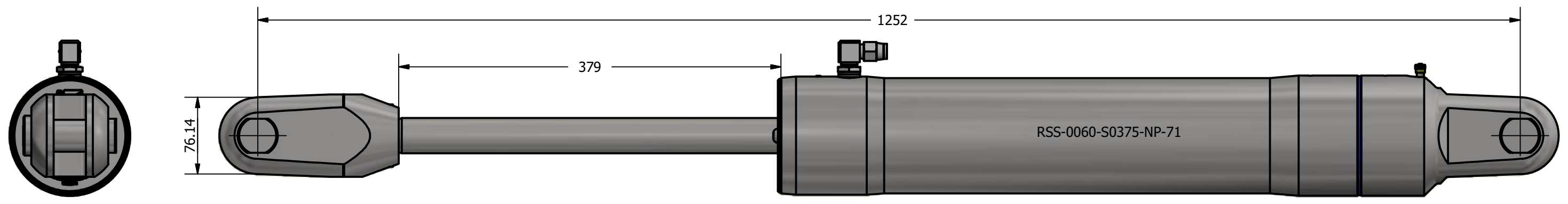
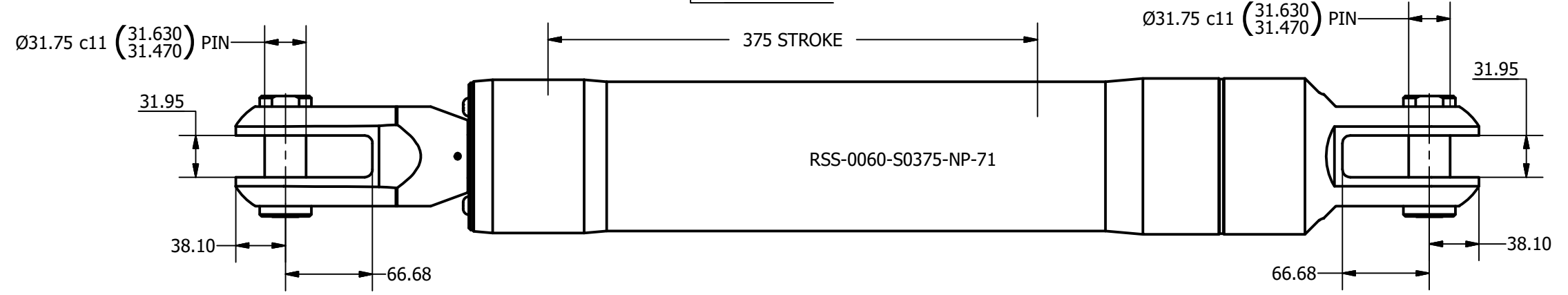
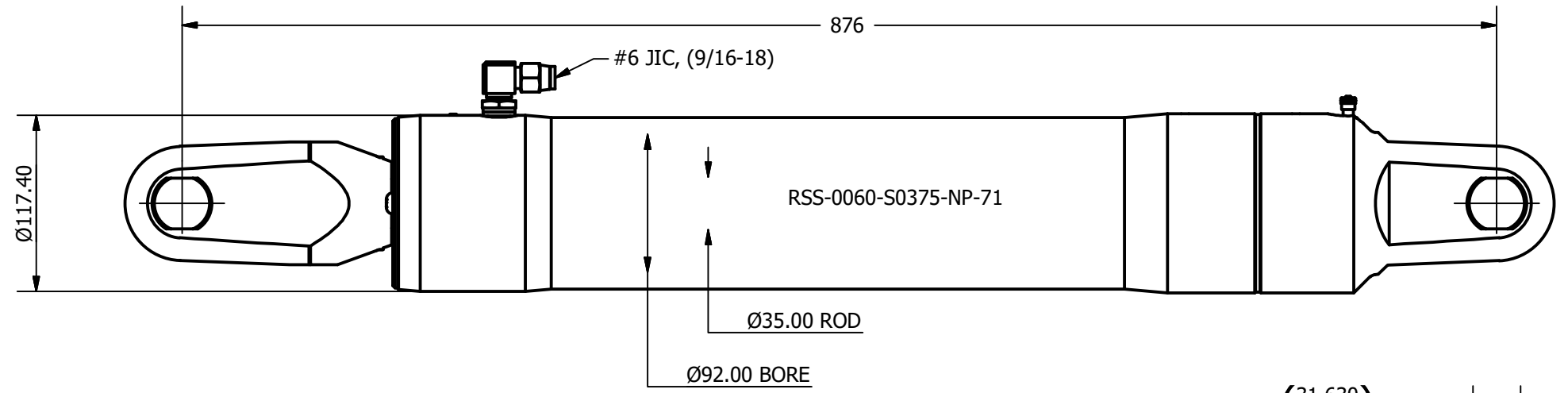

NOTE: CUSTOM STROKES, LENGTHS AND CLEVIS DIMENSIONS AVAILABLE UPON REQUEST

	Title STAINLESS SINGLE ACTING GAS RETURN CYLINDER		Revision 2
	Drawing No. RSS-0060-S0375-NP-71		Date Drawn 10/11/2021
	Tel: +44 (0)1202 596630 www.oms.ltd		By AL

© Copyright. All rights to this drawing and design are the sole property of OMS Ltd. This drawing must not be copied, communicated or loaned to any third party without the written consent of OMS Ltd.