

SIZE	-0030
PCLC	682 mm
PIN / GAP	22.23 mm
BORE DIA	65 mm
ROD DIA	24 mm
STROKE	300 mm
WEIGHT	16.95 Kg
FULL BORE AREA (PUSHING/EXTENDING)	3318 mm ²
ANNULUS AREA (PULLING/RETRACTING)	2866 mm ²
GAS DISPLACEMENT (FULL BORE SIDE)	1.00 ltrs
OIL DISPLACEMENT (ANNULUS SIDE)	0.86 ltrs
MAXIMUM PUSH FORCE @ 5 BAR	169 Kg (1659 N)
PULL FORCE @ 150 BAR	4382 Kg (42989 N)
PULL FORCE @ 250 BAR	7304 Kg (71648 N)
MAX PULL FORCE @ 350 BAR (RELIEF)	10225 Kg (100307 N)

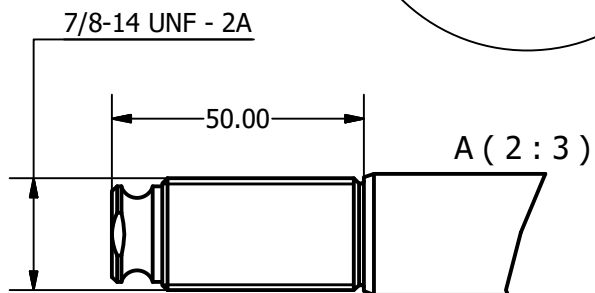
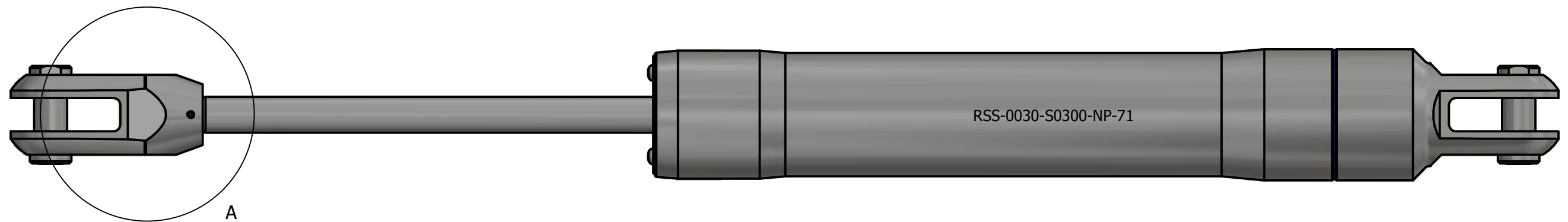
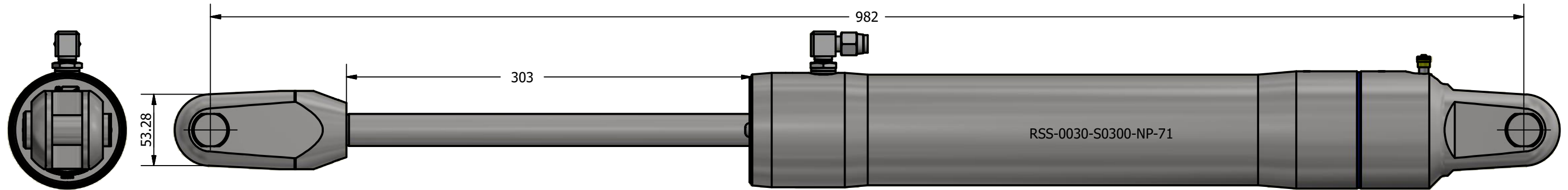
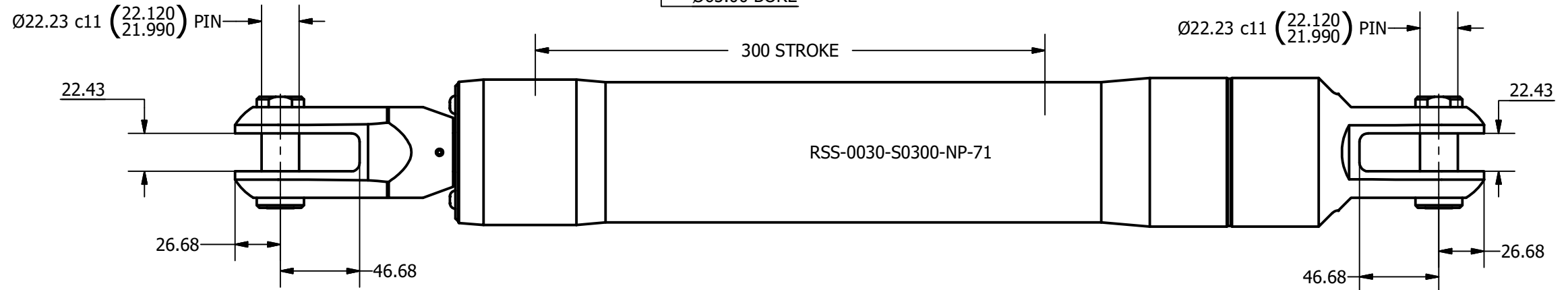
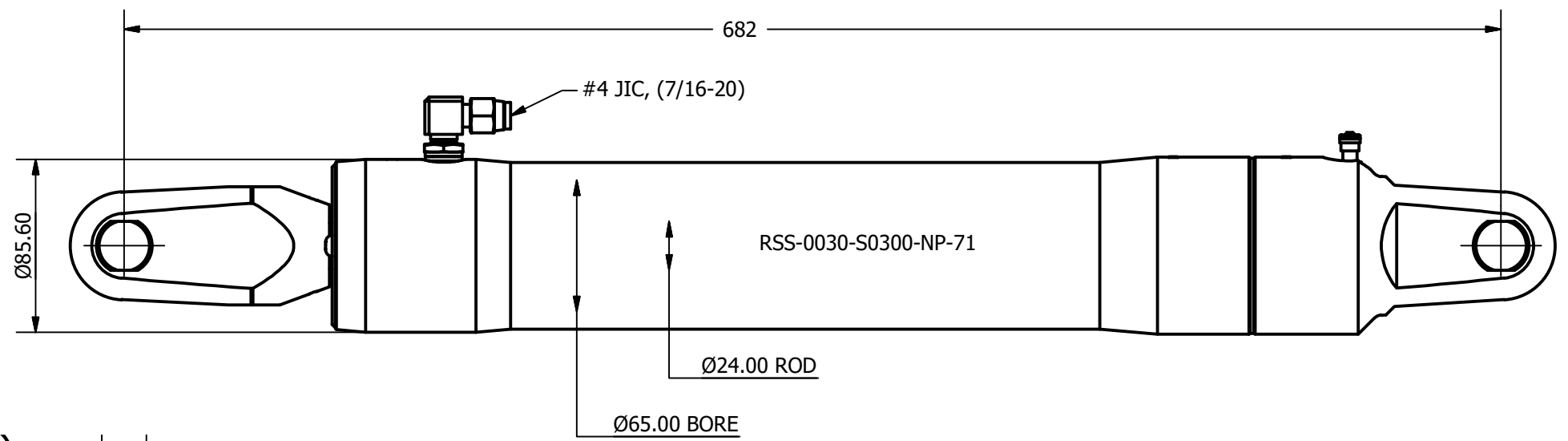

NOTE: CUSTOM STROKES, LENGTHS AND CLEVIS DIMENSIONS AVAILABLE UPON REQUEST

	Title STAINLESS SINGLE ACTING GAS RETURN CYLINDER		Revision 2
	Drawing No. RSS-0030-S0300-NP-71		Date Drawn By 10/11/2021 AL
	Tel: +44 (0)1202 596630 www.oms.ltd		© Copyright. All rights to this drawing and design are the sole property of OMS Ltd. This drawing must not be copied, communicated or loaned to any third party without the written consent of OMS Ltd.