

SIZE	-0022
PCLC	623 mm
PIN / GAP	19.05 mm
BORE DIA	56 mm
ROD DIA	20 mm
STROKE	275 mm
WEIGHT	11.5 Kg
FULL BORE AREA (PUSHING/EXTENDING)	2463 mm ²
ANNULUS AREA (PULLING/RETRACTING)	2149 mm ²
GAS DISPLACEMENT (FULL BORE SIDE)	0.68 ltrs
OIL DISPLACEMENT (ANNULUS SIDE)	0.59 ltrs
MAXIMUM PUSH FORCE @ 5 BAR	126 Kg (1232 N)
PULL FORCE @ 150 BAR	3286 Kg (32233 N)
PULL FORCE @ 250 BAR	5479 Kg (53721 N)
MAX PULL FORCE @ 350 BAR (RELIEF)	7667 Kg (75210 N)

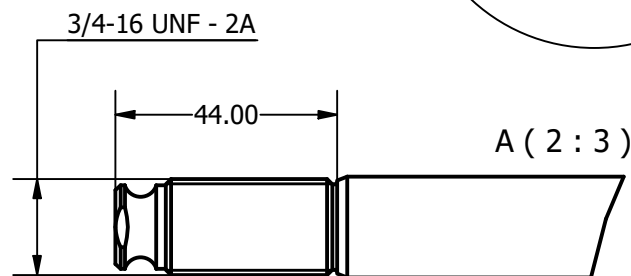
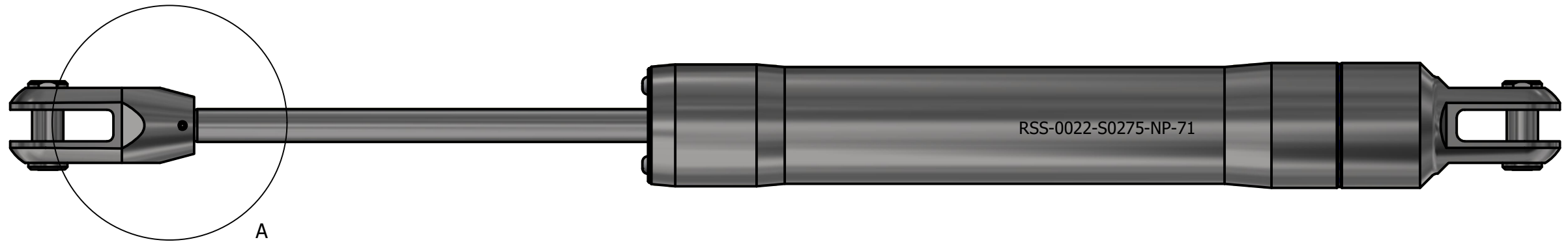
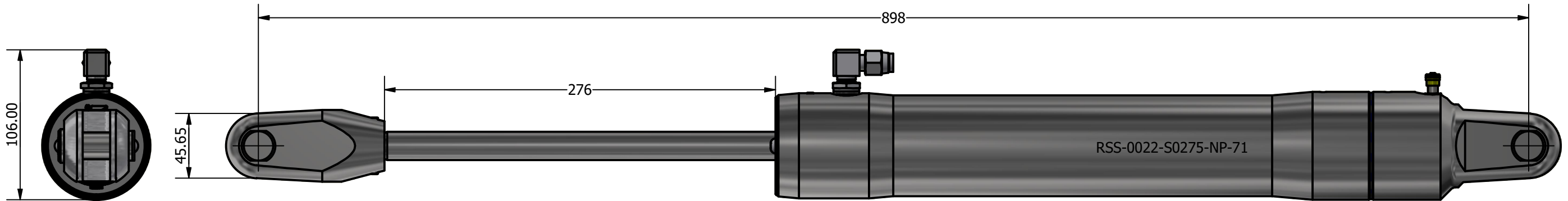
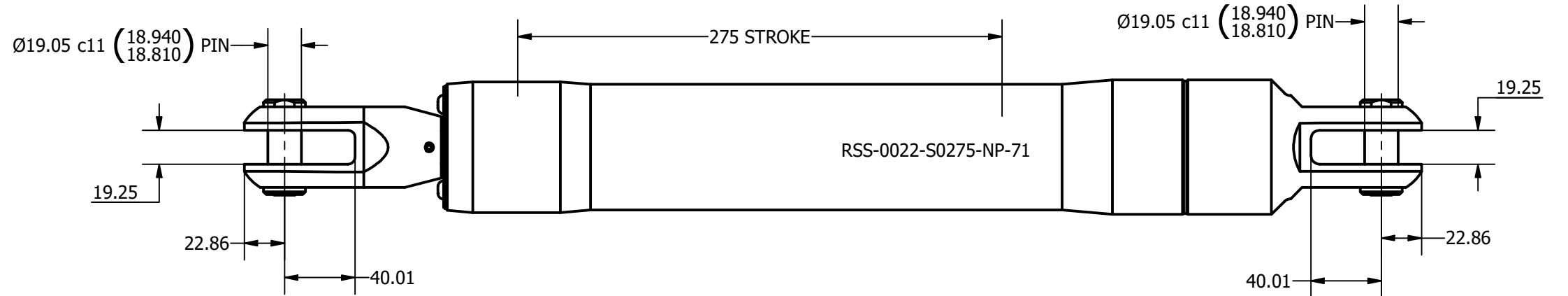
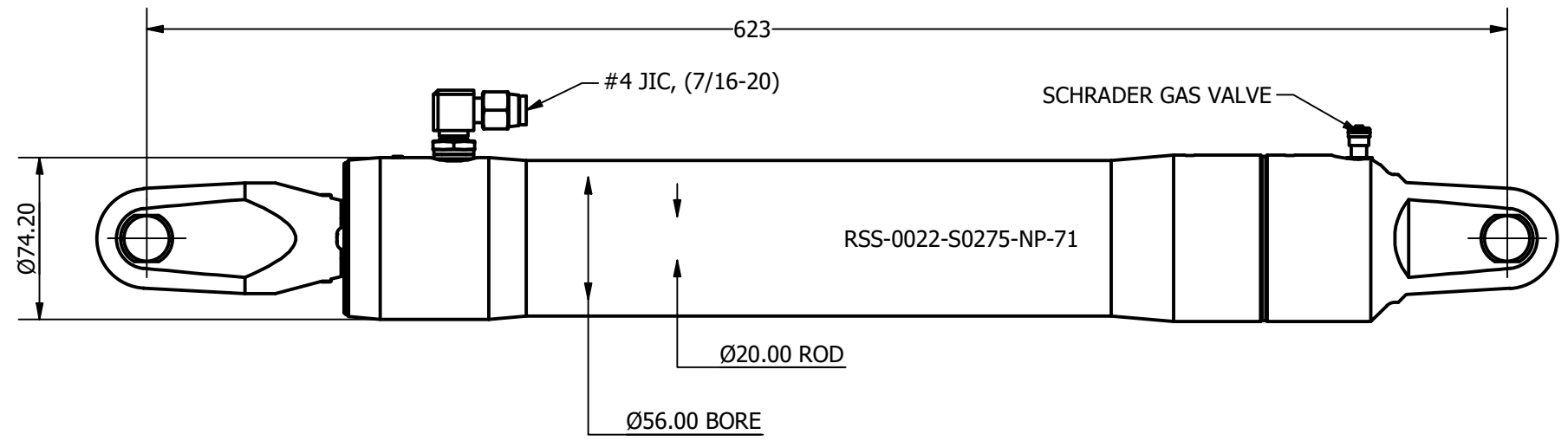

NOTE: CUSTOM STROKES, LENGTHS AND CLEVIS DIMENSIONS AVAILABLE UPON REQUEST

	Title STAINLESS SINGLE ACTING GAS RETURN CYLINDER		Revision 2
	Drawing No. RSS-0022-S0275-NP-71		Date Drawn By 10/11/2021 AL
	Tel: +44 (0)1202 596630 www.oms.ltd		© Copyright. All rights to this drawing and design are the sole property of OMS Ltd. This drawing must not be copied, communicated or loaned to any third party without the written consent of OMS Ltd.