

SIZE	-0048
PCLC	856 mm
PIN / GAP	28.58 mm
BORE DIA	82 mm
ROD DIA	26 mm
STROKE	475 mm
WEIGHT	13.12 Kg
FULL BORE AREA (PUSHING/EXTENDING)	5281 mm ²
ANNULUS AREA (PULLING/RETRACTING)	4750 mm ²
GAS DISPLACEMENT (FULL BORE SIDE)	2.51 ltrs
OIL DISPLACEMENT (ANNULUS SIDE)	2.26 ltrs
MAXIMUM PUSH FORCE @ 5 BAR	269 Kg (2641 N)
PULL FORCE @ 150 BAR	7263 Kg (71251 N)
PULL FORCE @ 250 BAR	12105 Kg (118752 N)
MAX PULL FORCE @ 350 BAR (RELIEF)	16947 Kg (166253 N)

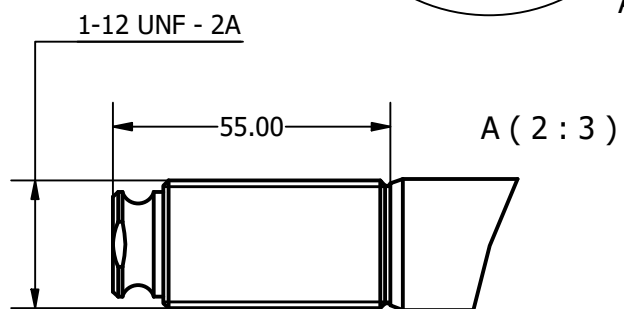
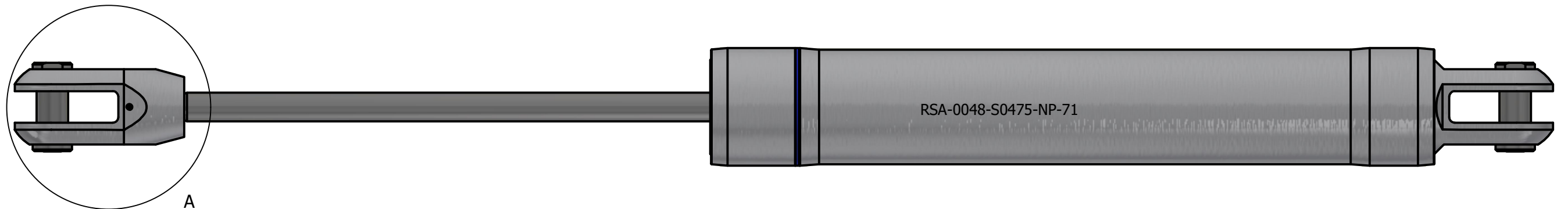
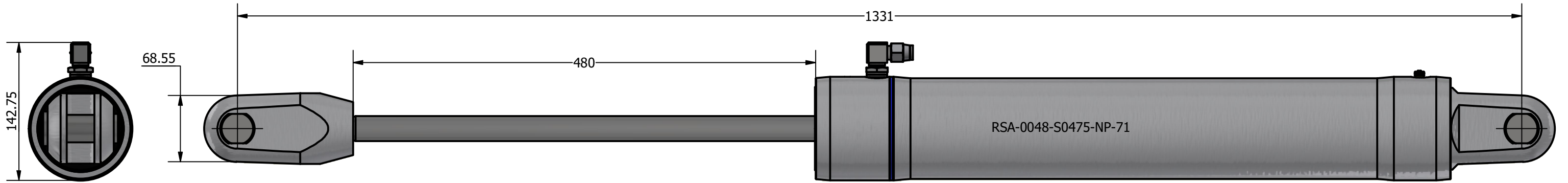
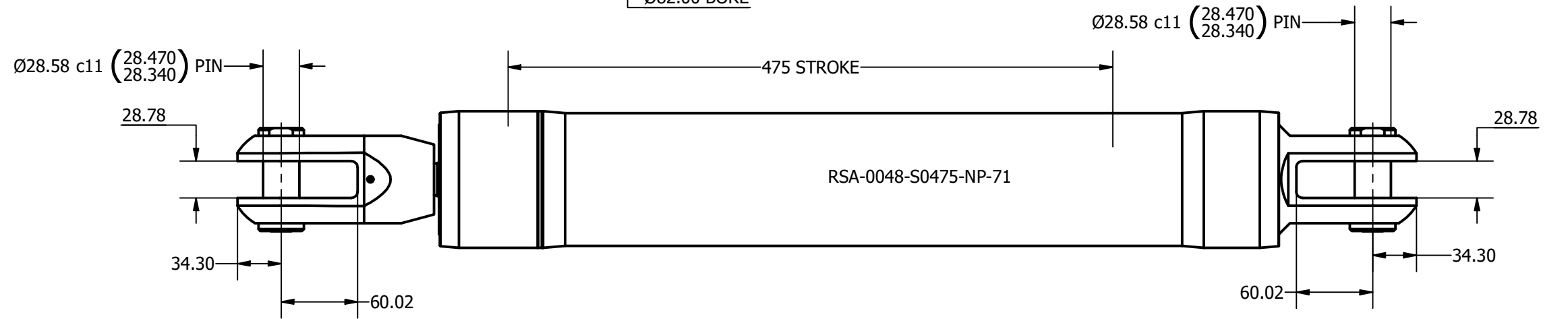
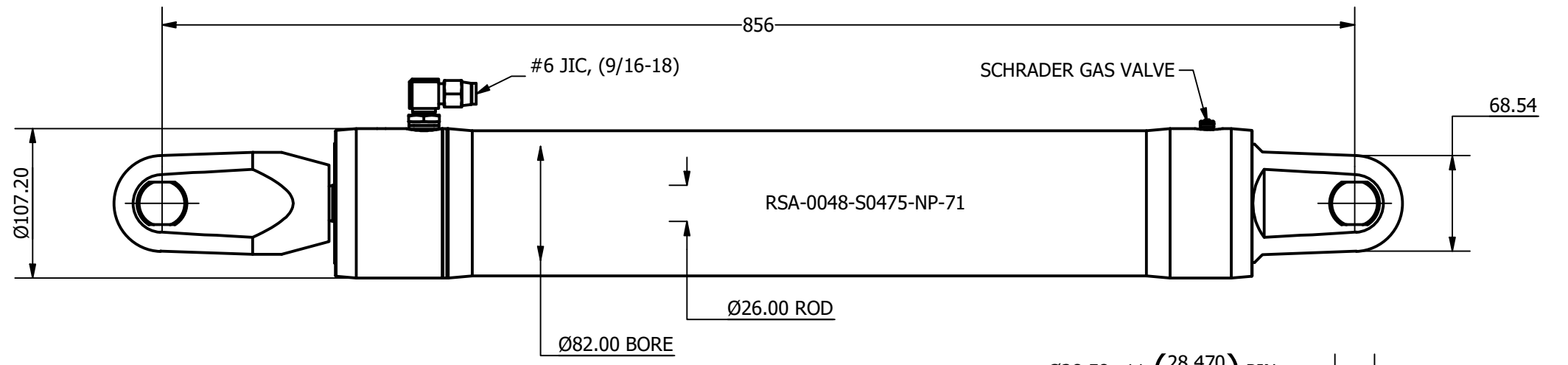

NOTE: CUSTOM STROKES, LENGTHS AND CLEVIS DIMENSIONS AVAILABLE UPON REQUEST

	Title ALUMINIUM SINGLE ACTING GAS RETURN CYLINDER		Revision 4
	Drawing No. RSA-0048-S0475-NP-71		Date Drawn 25/10/2021
	Tel: +44 (0)1202 596630 www.oms.ltd		By AL

© Copyright. All rights to this drawing and design are the sole property of OMS Ltd. This drawing must not be copied, communicated or loaned to any third party without the written consent of OMS Ltd.