

SIZE	-0012
PCLC	919 mm
PIN / GAP	15.88 mm
BORE DIA	40 mm
ROD DIA	18 mm
STROKE	625 mm
WEIGHT	3.98 Kg
FULL BORE AREA (PUSHING/EXTENDING)	1257 mm <sup>2</sup>
ANNULUS AREA (PULLING/RETRACTING)	1002 mm <sup>2</sup>
GAS DISPLACEMENT (FULL BORE SIDE)	0.79 ltrs
OIL DISPLACEMENT (ANNULUS SIDE)	0.63 ltrs
MAXIMUM PUSH FORCE @ 4 BAR	51 Kg (503 N)
PULL FORCE @ 150 BAR	1532 Kg (15033 N)
PULL FORCE @ 250 BAR	2554 Kg (25054 N)
MAX PULL FORCE @ 350 BAR (RELIEF)	3576 Kg (35076 N)

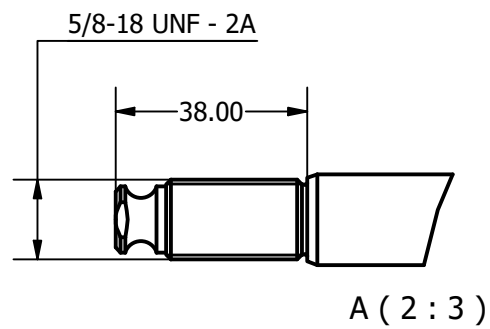
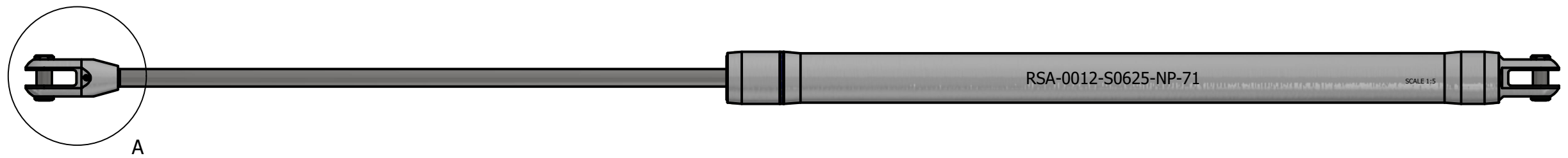
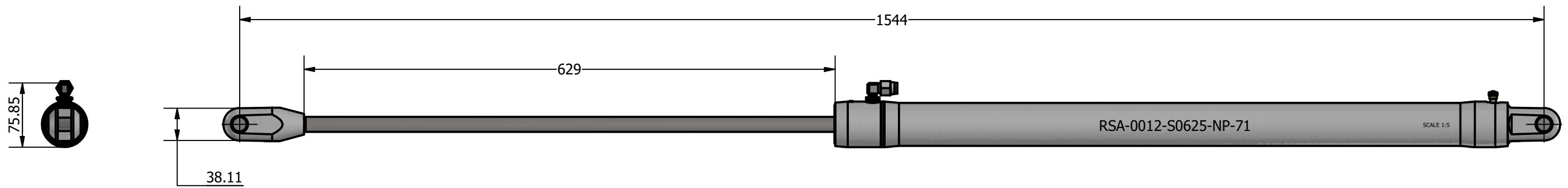
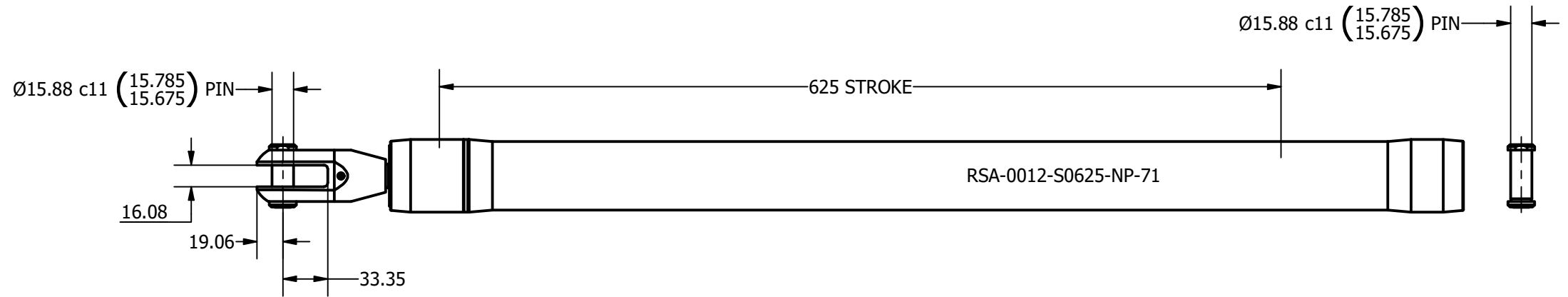
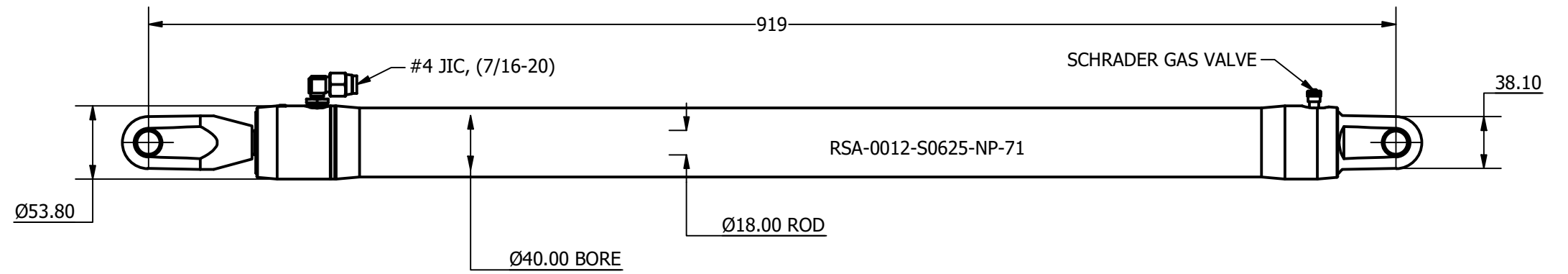

**NOTE: CUSTOM STROKES, LENGTHS AND CLEVIS DIMENSIONS AVAILABLE UPON REQUEST**

	Title ALUMINIUM SINGLE ACTING GAS RETURN CYLINDER		Revision 4
	Drawing No. RSA-0012-S0625-NP-71		Date Drawn By 21/10/2021 AL
	Tel: +44 (0)1202 596630 www.oms.ltd		© Copyright. All rights to this drawing and design are the sole property of OMS Ltd. This drawing must not be copied, communicated or loaned to any third party without the written consent of OMS Ltd.