

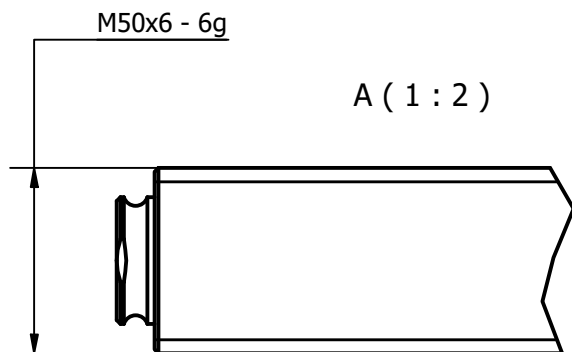

SIZE	-0150
PCLC	1931 mm
PIN / GAP	44.45 mm
BORE DIA	135 mm
ROD DIA	50 mm
STROKE	475 mm
WEIGHT	92.78 Kg
FULL BORE AREA (PUSHING/EXTENDING)	14314 mm ²
ANNULUS AREA (PULLING/RETRACTING)	12350 mm ²
GAS DISPLACEMENT (FULL BORE SIDE)	6.80 ltrs
OIL DISPLACEMENT (ANNULUS SIDE)	5.87 ltrs
MAXIMUM PUSH FORCE @ 5 BAR	730 Kg (7157 N)
PULL FORCE @ 150 BAR	18884 Kg (185256 N)
PULL FORCE @ 250 BAR	31474 Kg (308760 N)
MAX PULL FORCE @ 350 BAR (RELIEF)	44064 Kg (432264 N)

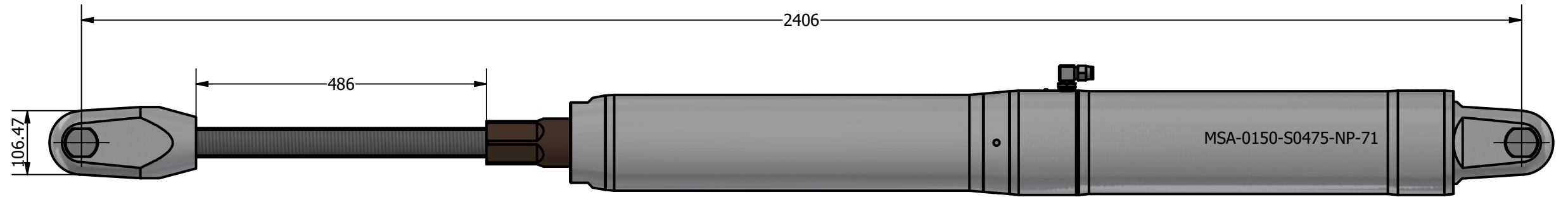
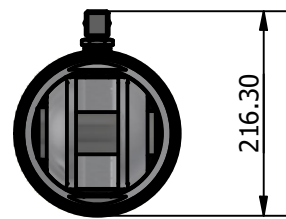
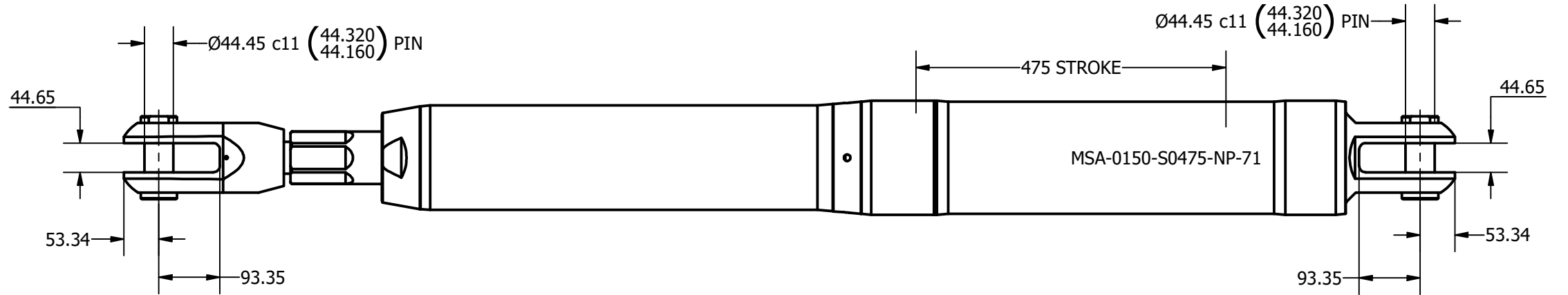
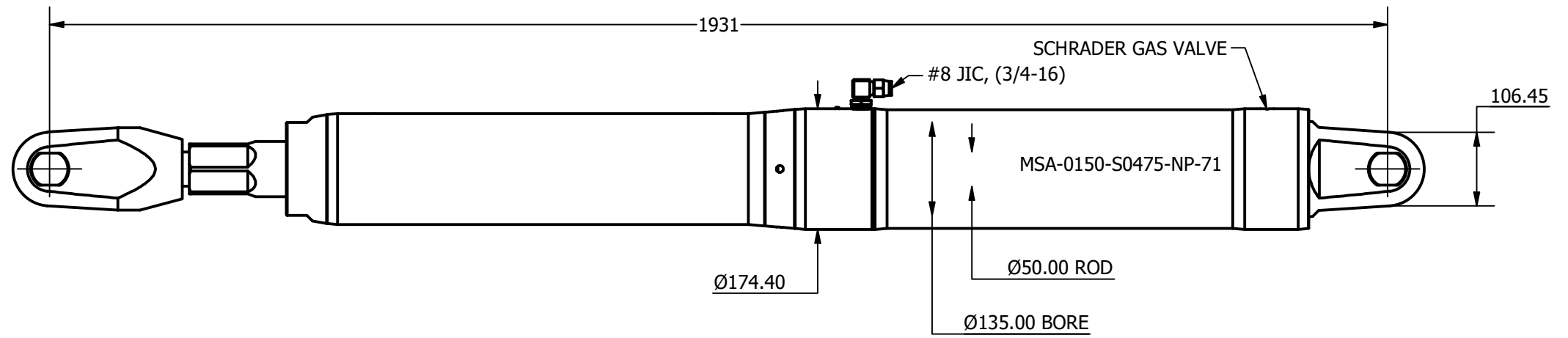

NOTE: CUSTOM STROKES, LENGTHS AND CLEVIS DIMENSIONS AVAILABLE UPON REQUEST

	Title ALUMINIUM SINGLE ACTING MECHANICAL LOCK CYLINDER		Revision 2
	Drawing No. MSA-0150-S0475-NP-71		Date Drawn 01/11/2021
	Tel: +44 (0)1202 596630 www.oms.ltd		By AL

© Copyright. All rights to this drawing and design are the sole property of OMS Ltd. This drawing must not be copied, communicated or loaned to any third party without the written consent of OMS Ltd.