

SIZE	-0115
PCLC	1826 mm
PIN / GAP	38.10 mm
BORE DIA	120 mm
ROD DIA	40 mm
STROKE	475 mm
WEIGHT	63.66 Kg
FULL BORE AREA (PUSHING/EXTENDING)	11310 mm ²
ANNULUS AREA (PULLING/RETRACTING)	10053 mm ²
GAS DISPLACEMENT (FULL BORE SIDE)	5.37 ltrs
OIL DISPLACEMENT (ANNULUS SIDE)	4.78 ltrs
MAXIMUM PUSH FORCE @ 5 BAR	576 Kg (5655 N)
PULL FORCE @ 150 BAR	15327 Kg (150796 N)
PULL FORCE @ 250 BAR	25620 Kg (251327 N)
MAX PULL FORCE @ 350 BAR (RELIEF)	35867 Kg (351858 N)

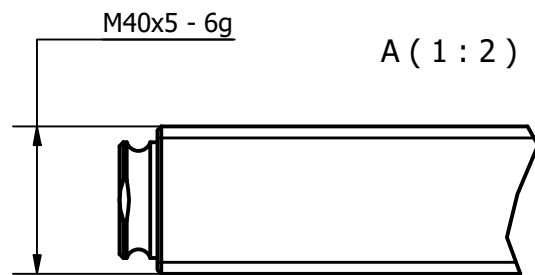
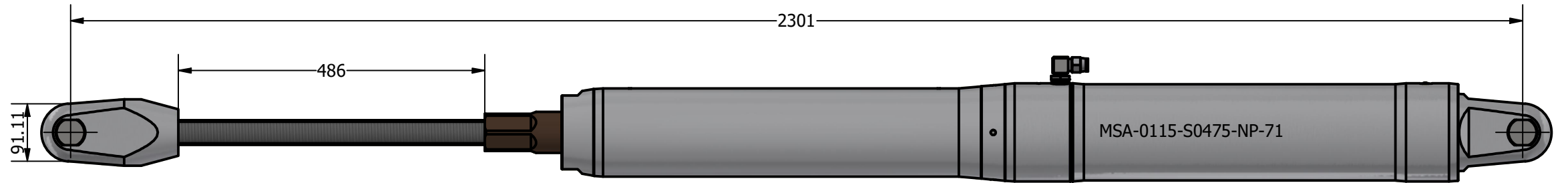
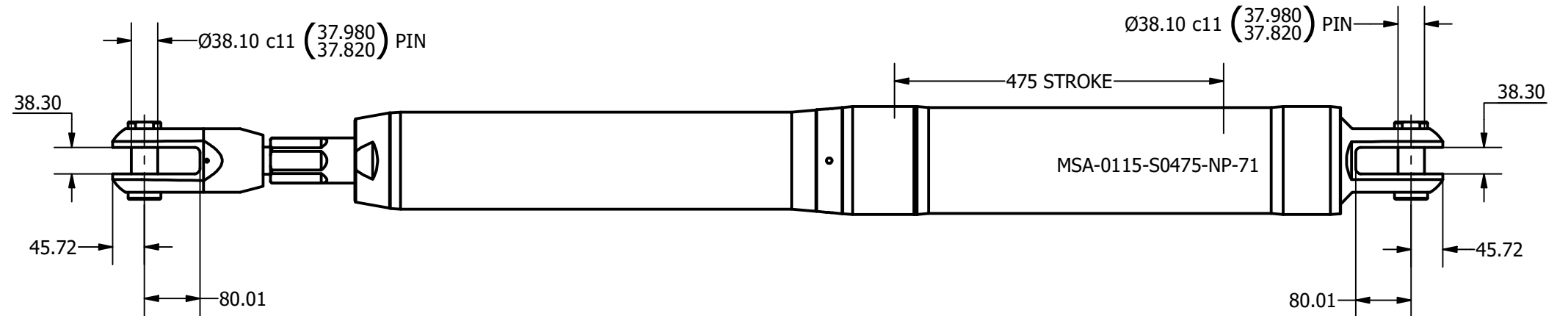
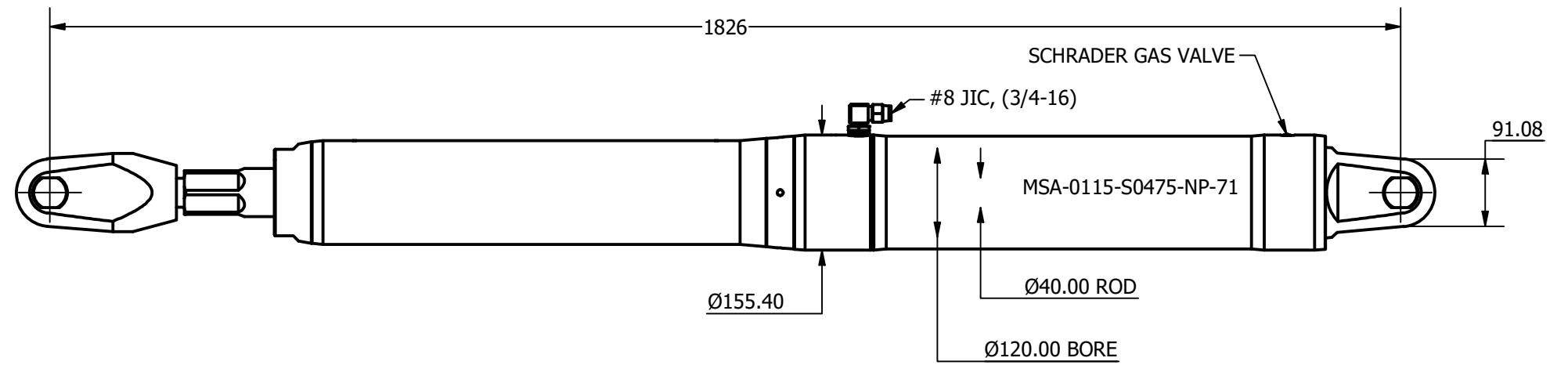

NOTE: CUSTOM STROKES, LENGTHS AND CLEVIS DIMENSIONS AVAILABLE UPON REQUEST

	Title ALUMINIUM SINGLE ACTING MECHANICAL LOCK CYLINDER		Revision 2
	Drawing No. MSA-0115-S0475-NP-71		Date Drawn By 01/11/2021 AL
	Tel: +44 (0)1202 596630 www.oms.ltd		© Copyright. All rights to this drawing and design are the sole property of OMS Ltd. This drawing must not be copied, communicated or loaned to any third party without the written consent of OMS Ltd.